

# Flex Bench MAX System



## Includes

Assembly Table



Router Table



Table Saw



Tool Tray & Knobs



Connector Kit



Extension Tables (4)



Extension Supports (8)



Ext. Table Brace



Router Plug



# Flex Bench SawStop System



## Includes

Assembly Table



Router Table



Saw Stop Table



Tool Tray & Knobs



Connector Kit



Extension Tables (4)



Extension Supports (8)



Ext. Table Brace



Router Plug



# READ FIRST

## 1) Layout pieces before assembly

*\*Example of possible Flex Bench System set up*



2) Set-up saw horses first with bottom placed on top.

3) NOTE: The Router & Assembly modules are square.

4) When laying out your sides, consider the placement of the cam side in relation to Router and Blue Dogs. We recommend the cam side be perpendicular to the Router Plate.

5) Hole will need to cut in bottom piece to accommodate your Router. See example on page 3

# READ FIRST



# Flex Router Bench Instructions

**BEFORE ASSEMBLY:**  
Cut hole in bottom base if needed for your Router

## Parts Included:

- 2 - Saw Horses ●
- 1 - Saw Horse Connector ●
- 1 - Router Plug (with magnets) ●
- 1 - Router Plug Support ●
- 1 - Cam Side Piece ●
- 3 - Open Side Pieces ●
- 1 - 32<sup>3</sup>/<sub>4</sub>" x 32<sup>3</sup>/<sub>4</sub>" Top ●
- 1 - 32<sup>3</sup>/<sub>4</sub>" x 32<sup>3</sup>/<sub>4</sub>" Bottom ●

## Hardware Kit

- 2 - 1/4-20 threaded inserts
- 4 - Saw Horse Feet
- 4 - KK.250 Screws

## Router Fence

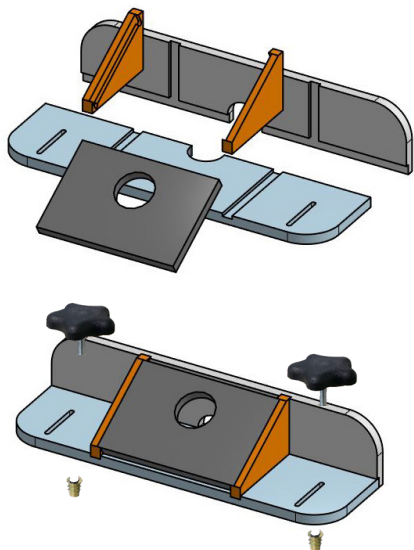

**Scan for Instructions:**



Router Fence Assembly  
<https://youtu.be/31-w5eNpCkv4>



Bench Assembly  
[https://youtu.be/49mKb\\_1EjRY](https://youtu.be/49mKb_1EjRY)

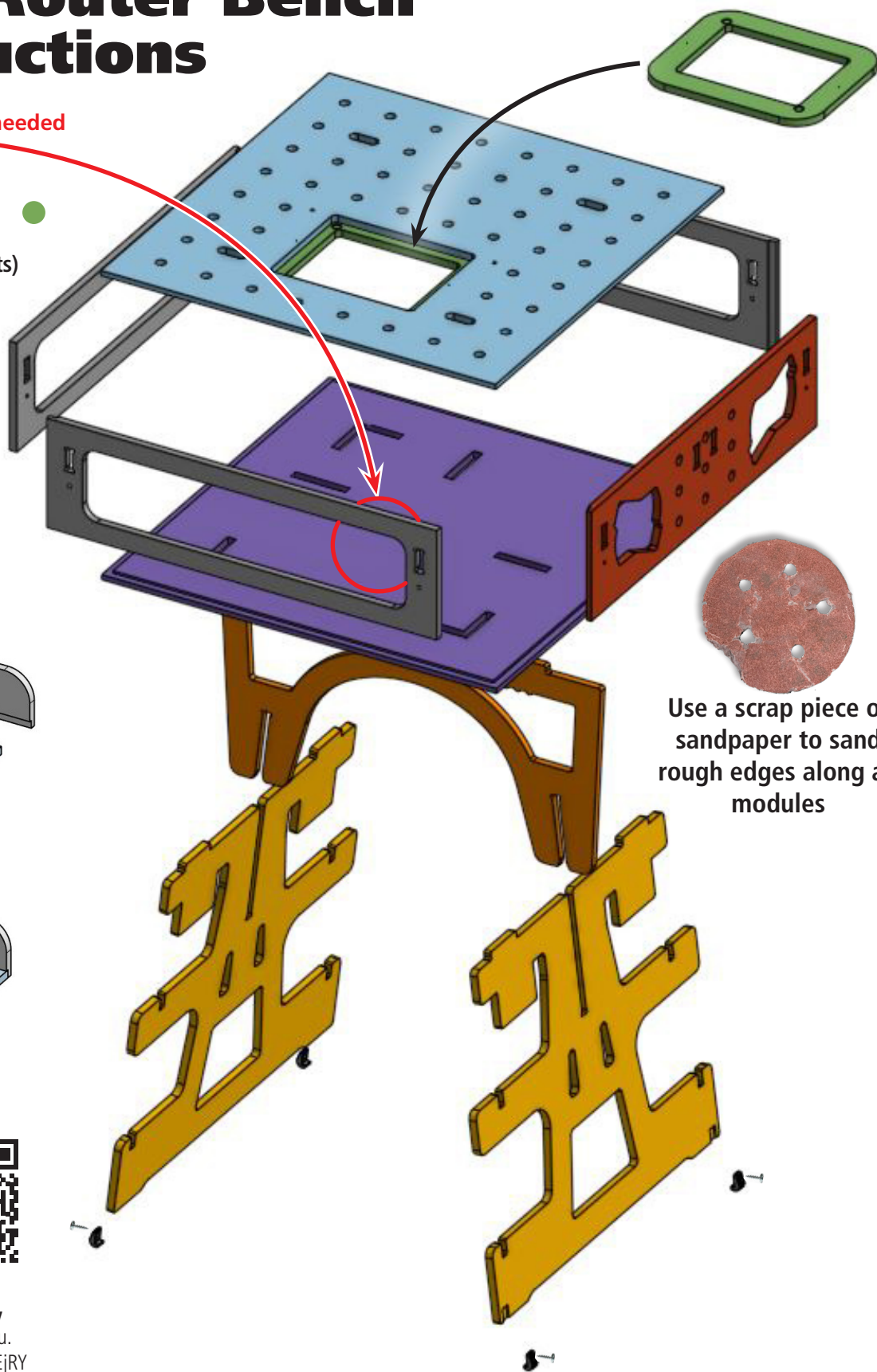







Use a scrap piece of sandpaper to sand rough edges along all modules



# Flex Assembly Bench Instructions

## Parts Included:

- 2 - Saw Horses 
- 1 - Saw Horse Connector 
- 5 - Blue Dogs 
- 3 - Open Sides Pieces 
- 1 - Cam Side Piece 
- 1 - 32 $\frac{3}{4}$ " x 32 $\frac{3}{4}$ " Top 
- 1 - 32 $\frac{3}{4}$ " x 32 $\frac{3}{4}$ " Bottom 

## Hardware Kit

- 4 - Saw Horse Feet
- 4 - KK.250 Screws

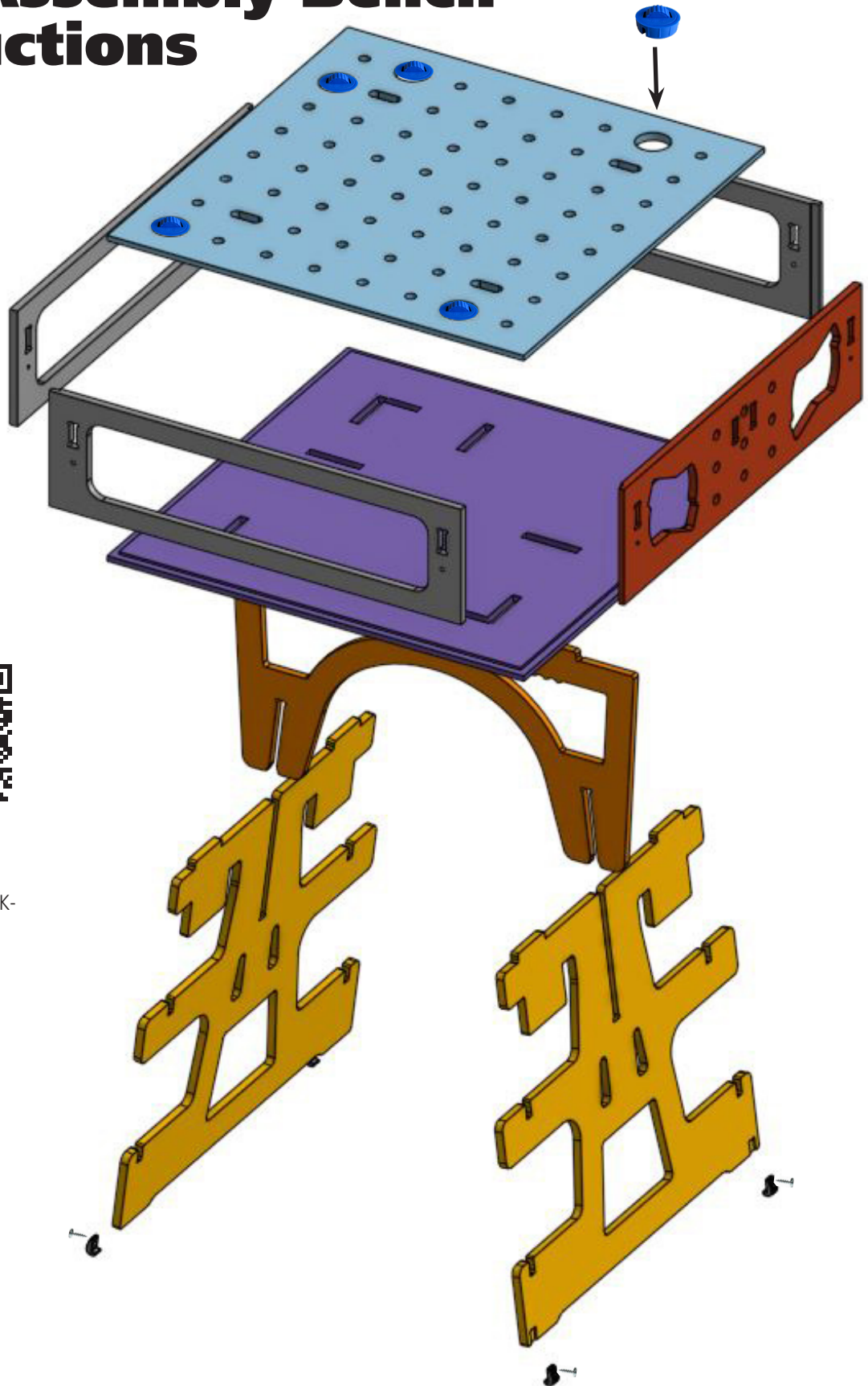

## Scan for Instructions:



**Bench Assembly**  
[https://youtu.be/49mKb\\_1EjRY](https://youtu.be/49mKb_1EjRY)



**Blue Dog**  
[https://www.youtube.com/watch?v=\\_27kKK-fOZEw&t=1s](https://www.youtube.com/watch?v=_27kKK-fOZEw&t=1s)

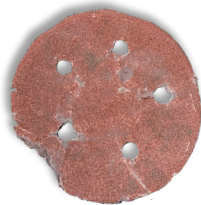

Use a scrap piece of sandpaper to sand rough edges along all modules



# Flex Table Saw Module Instructions

## Parts Included:

- 2 - Table Saw Horses 
- 1 - Table Saw Horse Connector 
- 1 - Table Saw Top 

## Hardware Kit

- 4 - Saw Horse Feet
- 4 - KK.250 Screws

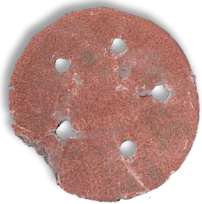

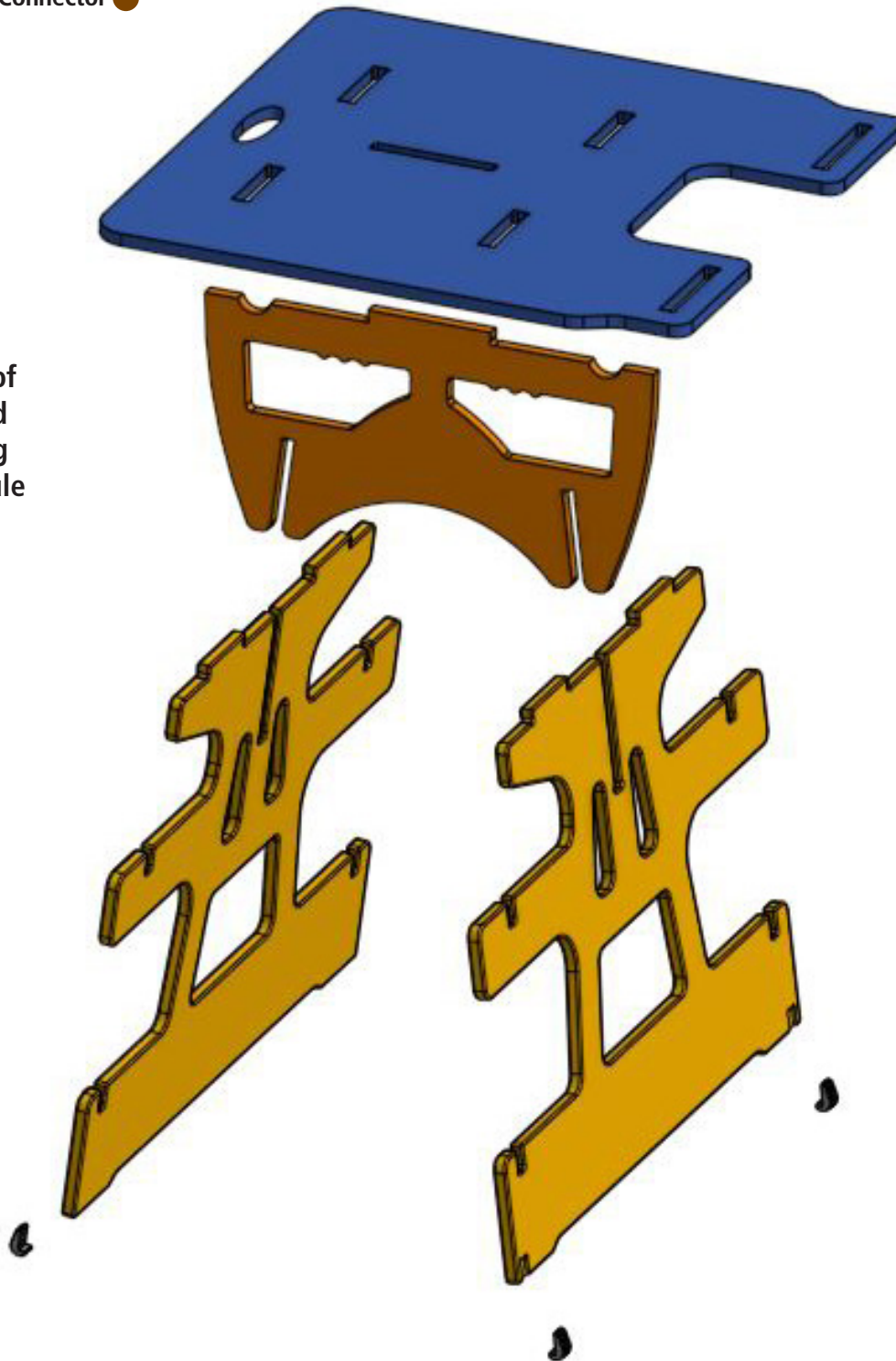

Use a scrap piece of sandpaper to sand rough edges along Flex Tool Tray Module





# Flex Saw Stop Module Instructions

## Parts Included:

- 2 - Table Saw Horses 
- 1 - Table Saw Horse Connector 
- 1 - Table Saw Top 

## Hardware Kit

- 4 - Saw Horse Feet
- 4 - KK.250 Screws
- 2 - Wood Blocks with SpeedTape
- 2 - Screws
- 2 - Knobs
- 1 - Strip of Fastcaps

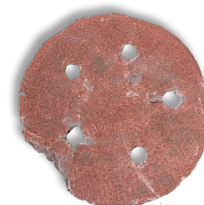

Use a scrap piece of sandpaper to sand rough edges along all modules

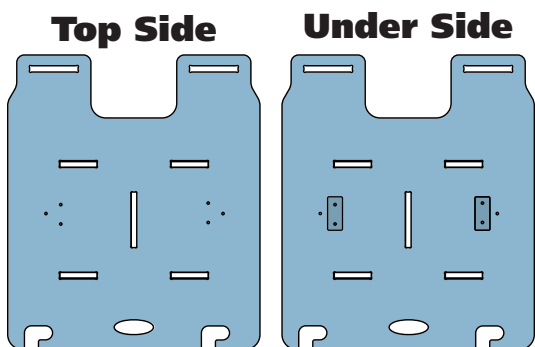

## Wood blocks and knobs installment instructions

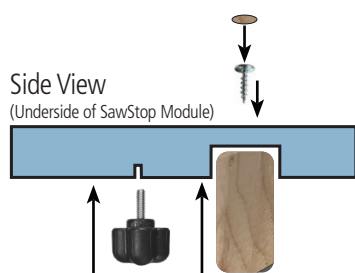

- Thread knob into small pre-drilled hole
- Remove SpeedTape liner from Wood Block and adhere inside pre-drilled rectangular pocket
- Use PowerHead screws to attach to Wood Block to SawStop and place Fastcaps over the screw head to have a finished look

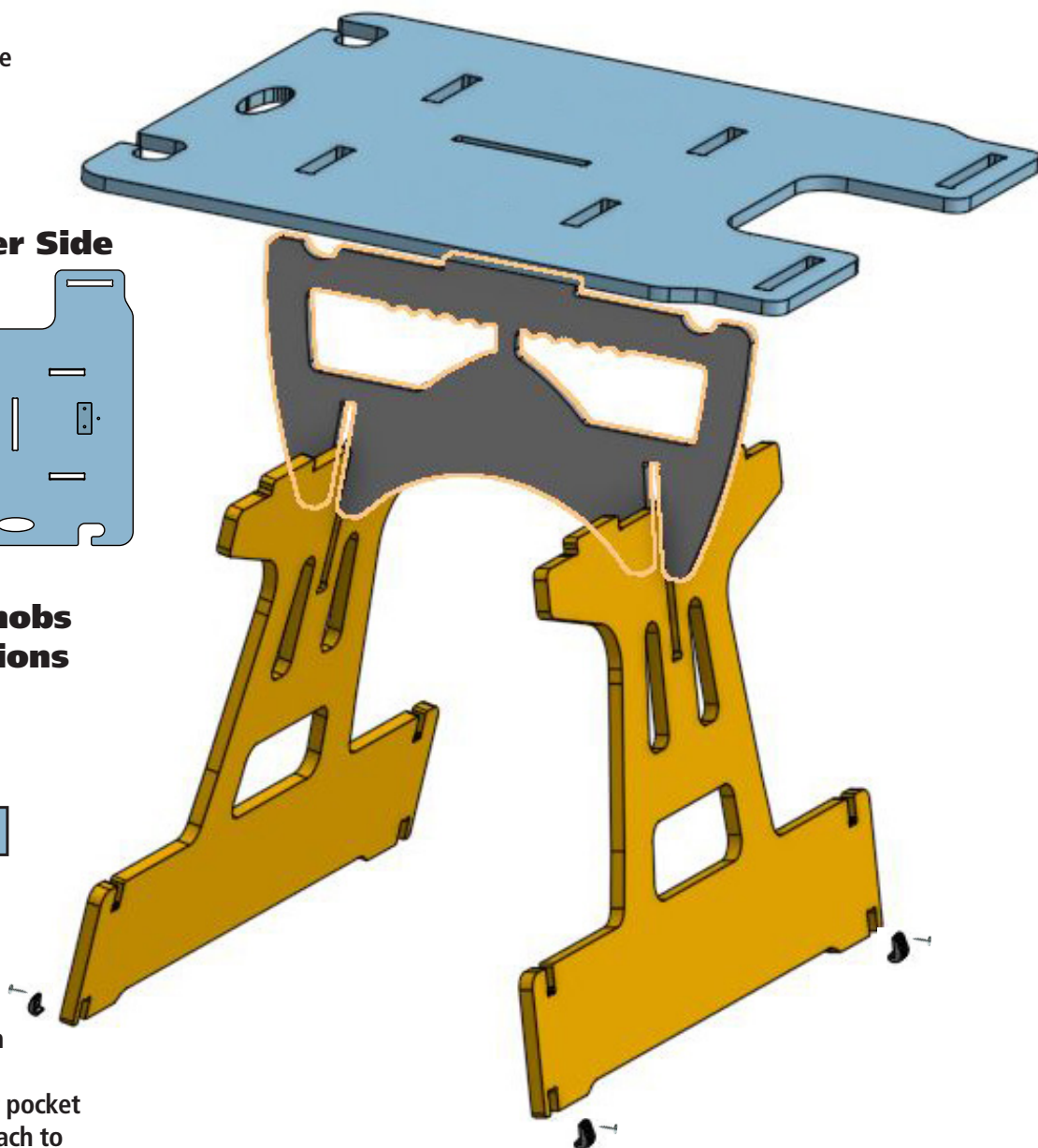



# Flex Tool Tray Module Instructions

## Parts Included:

- 1 - Tool Tray Table 
- 1 - Cam Lock Left 
- 1 - Cam Lock Right 
- 2 - Tool Tray H Sides 
- 1 - Tool Tray V Side Left 
- 1 - Tool Tray V Side Right 

## Hardware Kit

- 1.5" PowerHead Screws
- Knobs
- 1 - Torx Bit (T20)

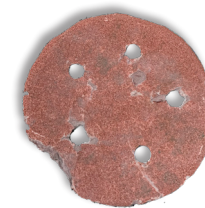

Use a scrap piece of sandpaper to sand rough edges along all modules

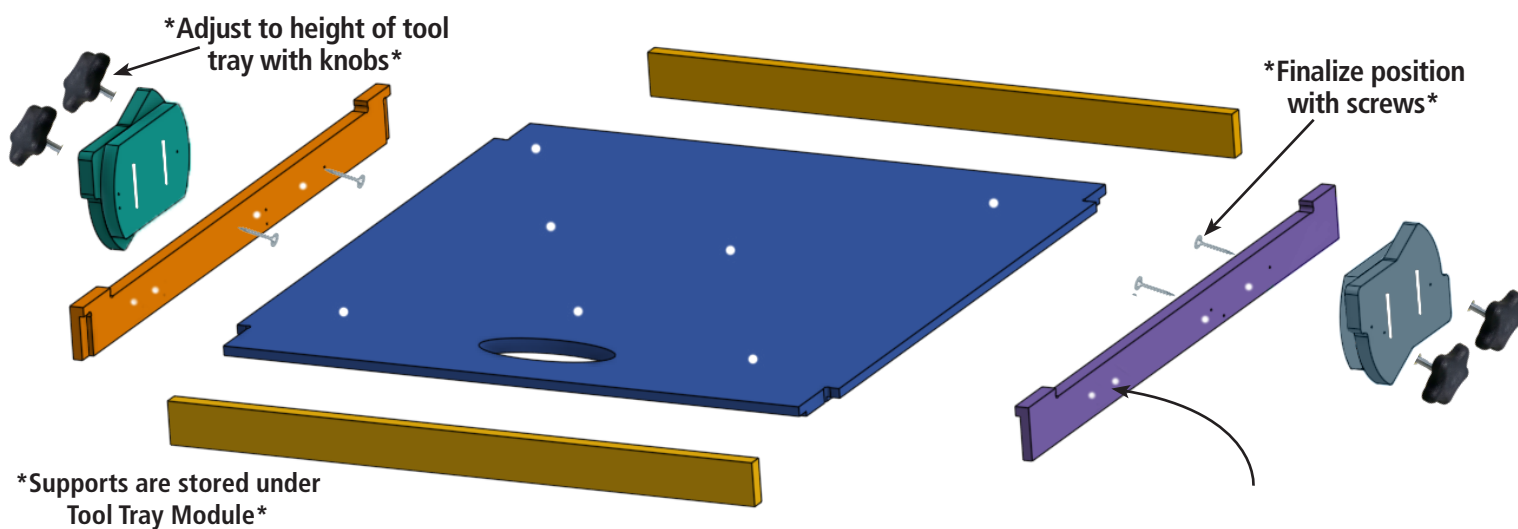

## Scan for Instructions:



Tool Tray Module Assembly  
<https://youtu.be/tDeGKUcM3LQ>

New & Improved Flex Bench  
<https://youtu.be/5oMhJFgpDik>



# Flex Extension Table Module Instructions

## Parts Included:

- 2 - Extension Table Tops ●
- 2 - Extension Table Supports ●

## Scan for Instructions:



New & Improved  
Flex Bench  
<https://youtu.be/5oMhJFgpDlk>

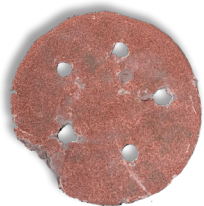
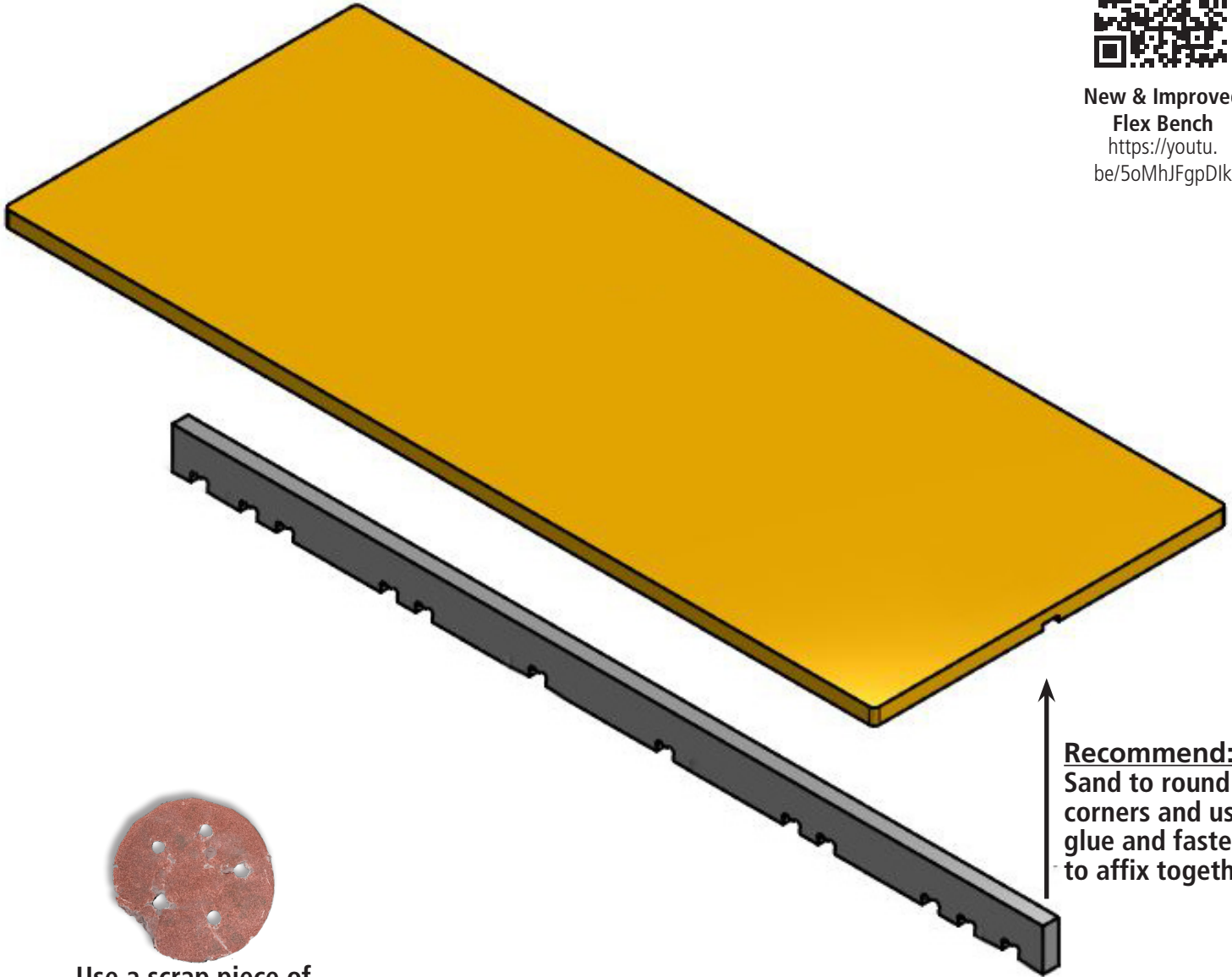

Use a scrap piece of sandpaper to sand rough edges along all modules

**Recommend:**  
Sand to round corners and use glue and fasteners to affix together